

## CGS74B2525 1-to-8 Minimum Skew Clock Driver

### General Description

This minimum skew clock driver is designed for Clock Generation and Support (CGS) applications operating well above 20 MHz (33 MHz, 50 MHz). The device guarantees minimum output skew across the outputs of a given device and also from device-to-device. Skew parameters are also provided as a means to measure duty cycle requirements as those found in high speed clocking systems. The 'B2525 is a minimum skew clock driver with one input driving eight outputs specifically designed for signal generation and clock distribution applications.

### Features

- Clock Generation and Support (CGS) Device—Ideal for high frequency signal generation or clock distribution applications
- CGS74B version features National's Advanced Bipolar FAST® LSI process
- 1-to-8 low skew clock distribution
- 600 ps pin-to-pin output skew
- Specifications for device-to-device variation of propagation delay
- Specification for transition skew to meet duty cycle requirements
- Center pin  $V_{CC}$  and GND configuration to minimize high speed switching noise
- Current sourcing 48 mA and current sinking of 64 mA
- Low dynamic power consumption above 20 MHz
- Guaranteed 4 kV ESD protection

### Logic Symbol

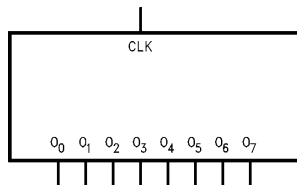

TL/F/10907-1

### Connection Diagram

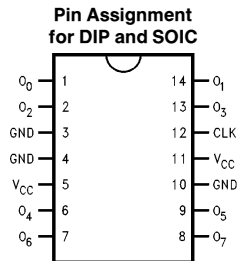

TL/F/10907-2

FAST® and TRI-STATE® are registered trademarks of National Semiconductor Corporation.

### Functional Description

#### Pin Description

Pin Names	Description
CLK	Clock Input
O <sub>0</sub> -O <sub>7</sub>	Outputs

### Truth Table

Inputs	Outputs
CLK	O <sub>0</sub> -O <sub>7</sub>
L	L
H	H

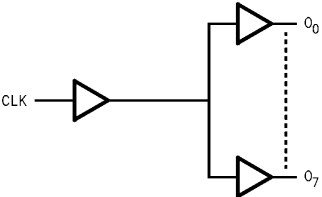

TL/F/10907-5

## Absolute Maximum Ratings (Note 1)

If Military/Aerospace specified devices are required, please contact the National Semiconductor Sales Office/Distributors for availability and specifications.

Supply Voltage ( $V_{CC}$ )	7.0V
Input Voltage ( $V_I$ )	7.0V
Operating Free Air Temperature	0°C to +70°C
Storage Temperature Range	-65°C to +150°C
Junction Temperature ( $\theta_{JA}$ )	
Plastic (N) Package	104 °C/W
JEDEC SOIC (M) Package	120 °C/W

## Recommended Operating Conditions

Supply Voltage ( $V_{CC}$ )	4.5V to 5.5V
Input Rise and Fall Times (0.8V to 2.0V)	9.6 ns max

Free Air Operating Temperature ( $T_A$ ) 0°C to +70°C

**Note 1:** The Absolute Maximum Ratings are those values beyond which the safety of the device cannot be guaranteed. The device should not be operated at these limits. The parametric values defined in the DC and AC Electrical Characteristics tables are not guaranteed at the absolute maximum ratings. The Recommended Operating Conditions will define the conditions for actual device operation.

## DC Electrical Characteristics

over recommended operating conditions unless specified otherwise. All typical values are measured at  $V_{CC} = 5V$ ,  $T_A = 25^\circ C$ .

Symbol	Parameter	Conditions	Min	Typ	Max	Units
$V_{IK}$	Input Clamp Voltage	$V_{CC} = 4.5V$ , $I_I = -18 mA$			-1.2	V
$V_{IH}$	Minimum Input High Level Voltage		2.0			V
$V_{IL}$	Maximum Input Low Level Voltage				0.8	V
$V_{OH}$	High Level Output Voltage	$I_{OH} = -3 mA$ , $V_{CC} = 4.5V$	2.4			V
		$I_{OH} = -48 mA$ , $V_{CC} = 4.5V$	2.0			
$V_{OL}$	Low Level Output Voltage	$V_{CC} = 4.5V$ , $I_{OL} = 64 mA$		0.35	0.5	V
$I_I$	Input Current @ Max Input Voltage	$V_{CC} = 5.5V$ , $V_{IH} = 7V$			0.1	mA
$I_{IH}$	High Level Input Current	$V_{CC} = 5.5V$ , $V_{IH} = 2.7V$			20	$\mu A$
$I_{IL}$	Low Level Input Current	$V_{CC} = 5.5V$ , $V_{IH} = 0.4V$			-0.5	mA
$I_O$	Output Drive Current	$V_{CC} = 5.5V$ , $V_O = 2.25V$	-50		-150	mA
$I_{CC}$	Supply Current	$V_{CC} = 5.5V$	Outputs High	8	15	mA
			Outputs Low	32	42	mA
$C_{IN}$	Input Capacitance	$V_{CC} = 5V$		5		pF

## AC Electrical Characteristics

Over recommended operating conditions unless specified otherwise.

Symbol	Parameter	CGS74B2525			Units
		V <sub>CC</sub> = 4.5V to 5.5V R <sub>L</sub> = 500Ω, C <sub>L</sub> = 50 pF			
		Min	Typ	Max	
t <sub>PLH</sub>	Propagation Delay	2	3.0	4.8	ns
t <sub>PHL</sub>	CLK to O <sub>n</sub>	2	3.0	4.8	

## Extended AC Electrical Characteristics

Over recommended operating conditions unless specified otherwise.

Symbol	Parameter	CGS74B2525			Units
		V <sub>CC</sub> = 4.5V to 5.5V R <sub>L</sub> = 500Ω, C <sub>L</sub> = 50 pF, T <sub>A</sub> = 0°C to 70°C			
		Min	Typ	Max	
f <sub>max</sub>	Maximum Operating Frequency	50			MHz
t <sub>OSSL</sub>	Maximum Skew Common Edge Output-to-Output Variation (Note 2)		150	600	ps
t <sub>OSLH</sub>	Maximum Skew Common Edge Output-to-Output Variation (Note 2)		150	600	ps
t <sub>OST</sub>	Maximum Skew Opposite Edge Output-to-Output Variation (Note 2)		0.7	1.5	ns
t <sub>PV</sub>	Maximum Skew Part-to-Part Variation Skew (Note 3)			1.75	ns
t <sub>PS</sub>	Maximum Skew Pin (Signal) Transition Variation (Note 2)		0.6	1.5	ns
t <sub>rise</sub> , t <sub>fall</sub>	Maximum Rise/Fall Time (from 0.8V to 2.0V/2.0V to 0.8V)			1.6 1.4	ns ns

**Note 2:** Output-to-Output Skew is defined as the absolute value of the difference between the actual propagation delay for any outputs within the same packaged device. The specifications apply to any outputs switching in the same direction either HIGH to LOW (t<sub>OSSL</sub>) or LOW to HIGH (t<sub>OSLH</sub>) or in opposite directions both HL and LH (t<sub>OST</sub>). Parameters t<sub>OST</sub> and t<sub>PS</sub> guaranteed by design. t<sub>OSSL</sub> and t<sub>OSLH</sub> are characterized and guaranteed by design @ 1 MHz.

**Note 3:** Part-to-part skew is defined as the absolute value of the difference between the propagation delay for any outputs from device to device. The parameter is specified for a given set of conditions (i.e., capacitive load, V<sub>CC</sub>, temperature, # of outputs switching, etc.). Parameter guaranteed by design.

**Note 4:** Load capacitance includes the test jig.

## Timing Diagrams

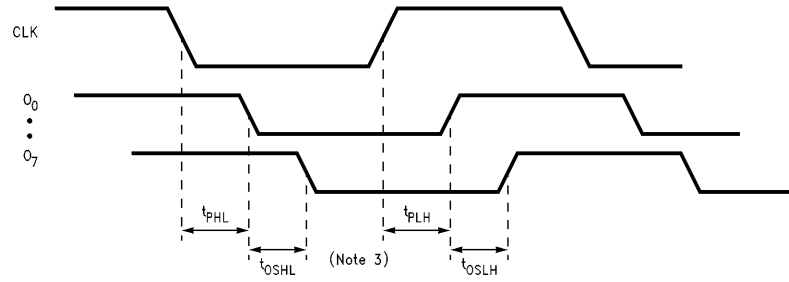

TL/F/10907-16

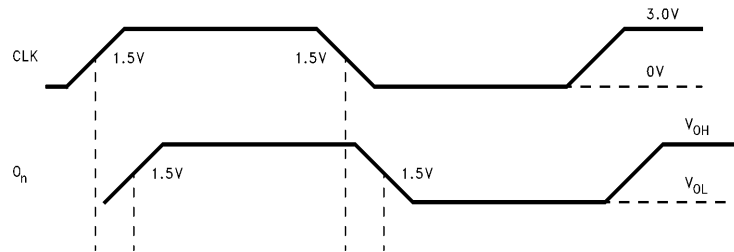

TL/F/10907-17

## Test Circuit

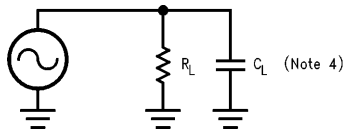

$R_L$  is  $500\Omega$   
 $C_L$  is 50 pF for all prop delays and skew measurements

TL/F/10907-18

## Ordering Information

The device number is used to form part of a simplified purchasing code where the package type and temperature range are defined as follows:

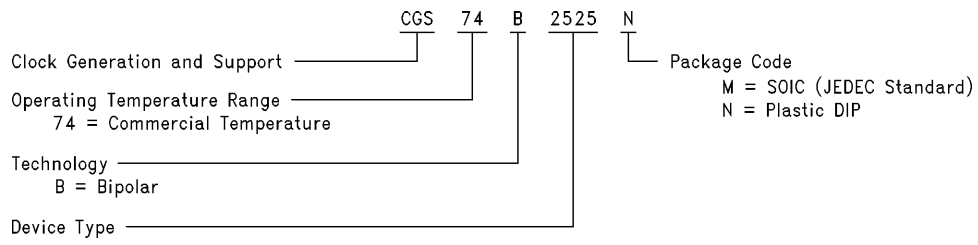

TL/F/10907-19

**Physical Dimensions** inches (millimeters)

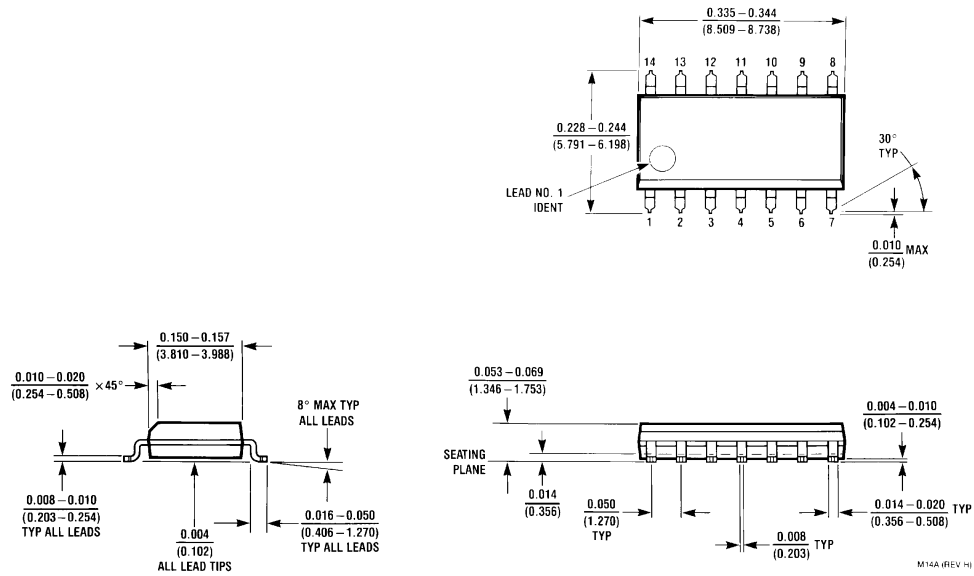

**14-Lead Small Outline Integrated Circuit  
NS Package Number M14A**

M14A (REV H)

**Physical Dimensions** inches (millimeters) (Continued)

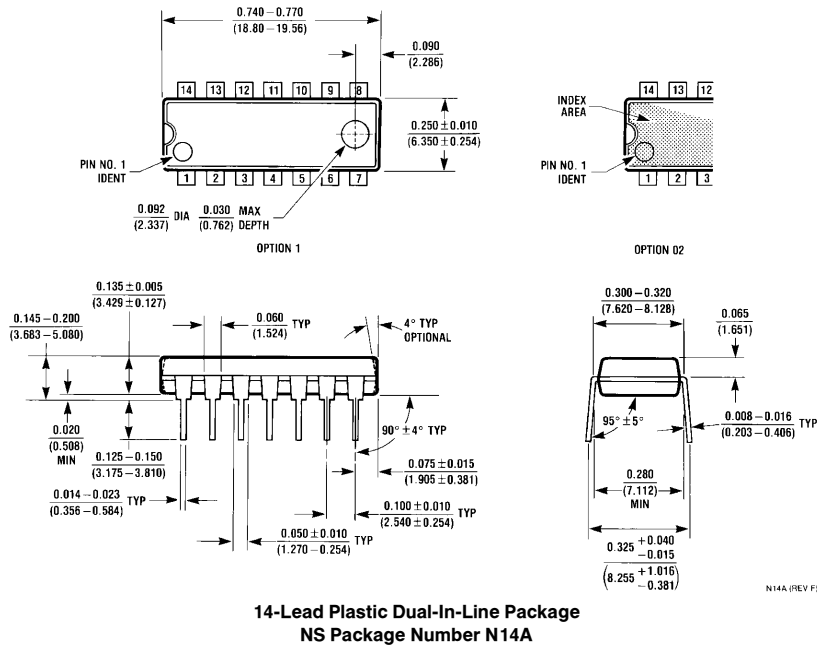

N14A (REV F)

**LIFE SUPPORT POLICY**

NATIONAL'S PRODUCTS ARE NOT AUTHORIZED FOR USE AS CRITICAL COMPONENTS IN LIFE SUPPORT DEVICES OR SYSTEMS WITHOUT THE EXPRESS WRITTEN APPROVAL OF THE PRESIDENT OF NATIONAL SEMICONDUCTOR CORPORATION. As used herein:

1. Life support devices or systems are devices or systems which, (a) are intended for surgical implant into the body, or (b) support or sustain life, and whose failure to perform, when properly used in accordance with instructions for use provided in the labeling, can be reasonably expected to result in a significant injury to the user.
2. A critical component is any component of a life support device or system whose failure to perform can be reasonably expected to cause the failure of the life support device or system, or to affect its safety or effectiveness.



**National Semiconductor Corporation**  
1111 West Bardin Road  
Arlington, TX 76017  
Tel: 1(800) 272-9959  
Fax: 1(800) 737-7018

**National Semiconductor Europe**  
Fax: (+49) 0-180-530 85 86  
Email: cnjwge@tevm2.nsc.com  
Deutsch Tel: (+49) 0-180-530 85 85  
English Tel: (+49) 0-180-532 78 32  
Français Tel: (+49) 0-180-532 93 58  
Italiano Tel: (+49) 0-180-534 16 80

**National Semiconductor Hong Kong Ltd.**  
19th Floor, Straight Block,  
Ocean Centre, 5 Canton Rd.  
Tsimshatsui, Kowloon  
Hong Kong  
Tel: (852) 2737-1600  
Fax: (852) 2736-9960

**National Semiconductor Japan Ltd.**  
Tel: 81-043-299-2309  
Fax: 81-043-299-2408

National does not assume any responsibility for use of any circuitry described, no circuit patent licenses are implied and National reserves the right at any time without notice to change said circuitry and specifications.